



15 Series

Fast and powerful precision machining centers
for profitable production - with one, two or four spindles

Productive, fast and compact

Leading-edge technology offering high reliability, performance and precision

Range of applications	[04–05]
Machine design	[06–07]
Extension options	[08–21]
Services	[22–23]



FZ15 W
Machining center with basket tool changer (20 tool) and workpiece changing device 0°/180°, enabling loading and unloading during machining.



CHIRON 15 series vertical machining centers are among the best machine tools in their class in terms of speed, dynamics, compact construction, stability and reliability. With ample power for great milling capacity, the CHIRON 15 series can be supplied as single, double, four-spindle or multi-profile versions, and are characterized by:

- Reliably high productivity
- Highest precision and processing quality
- Reduced space requirements
- Fast set-up
- Simple operation
- High stability
- High dynamics
- Easy maintenance

Due to their modular structure and numerous configuration options, every basic machine of the 15 series can be combined to provide a perfectly customized solution.

Your benefits: High precision and cutting capacity, as well as high machine availability and lower cost per piece.

Precision without compromise

Wide variety of workpieces – excellent surface quality

▶ Range of applications	[04–05]
Machine design	[06–07]
Extension options	[08–21]
Services	[22–23]

Automotive
e.g., machining of casing or steering boxes
[535 x 100 x 100 mm]

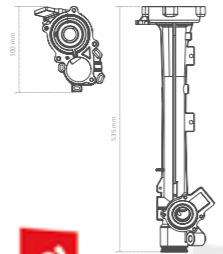

Aerospace
An example of 4-sided complete machining of extruded profiles with the CHIRON FZ15 MP, aluminum structured profile [1,600 mm x 75 mm]

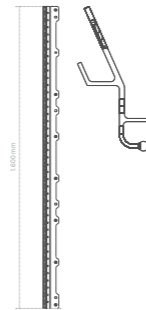

Automotive
Lowest cost-per-piece, complete machining of vehicle components such as: connecting rods and cylinders

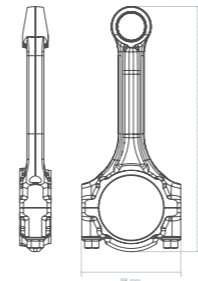

Machine construction
Milling, drilling, threading and turning in a single set-up, e.g. 5-axis complete machining of integral components for motor saws (casing parts of magnesium), cylinders, pistons, connecting rods, blades, etc.

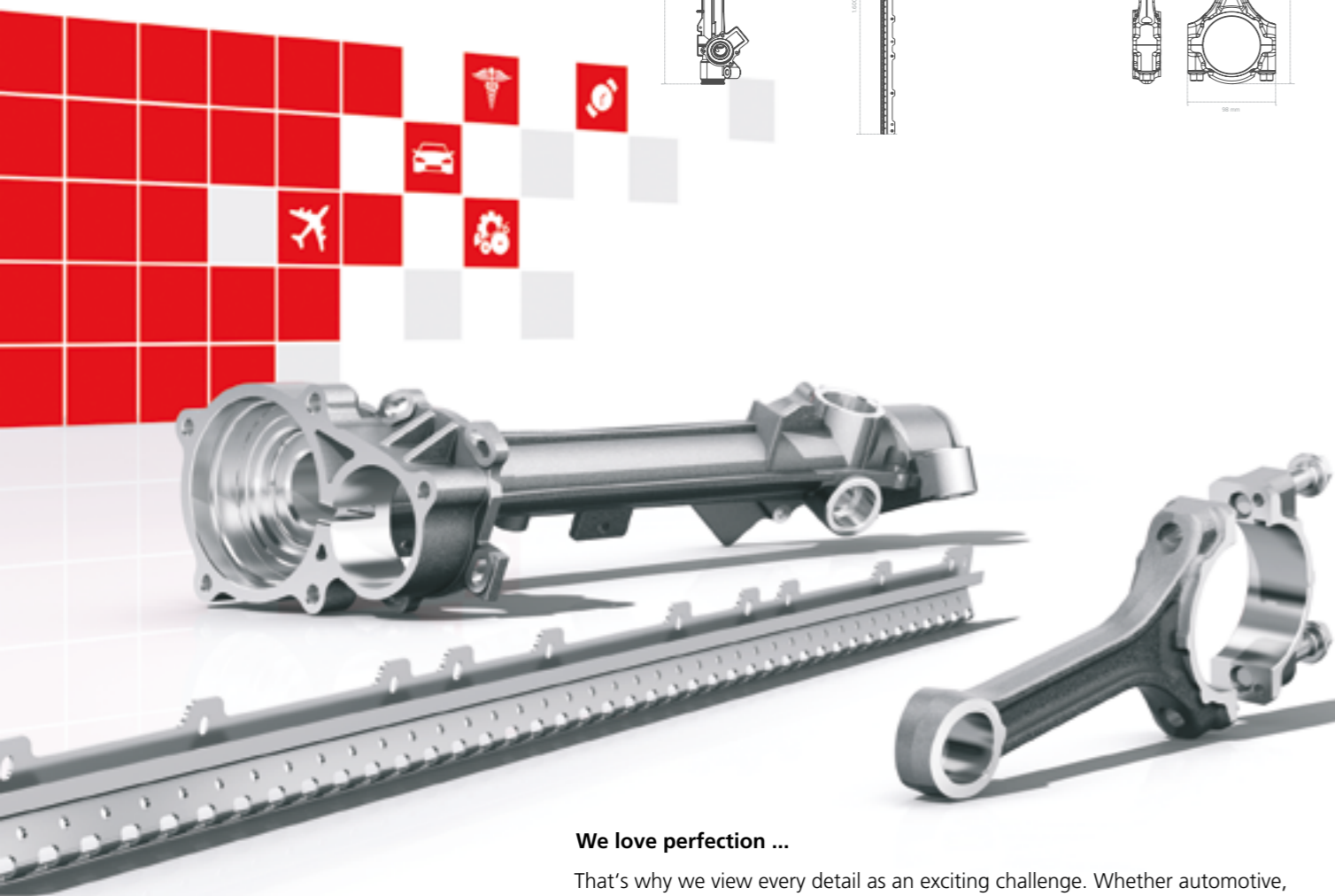
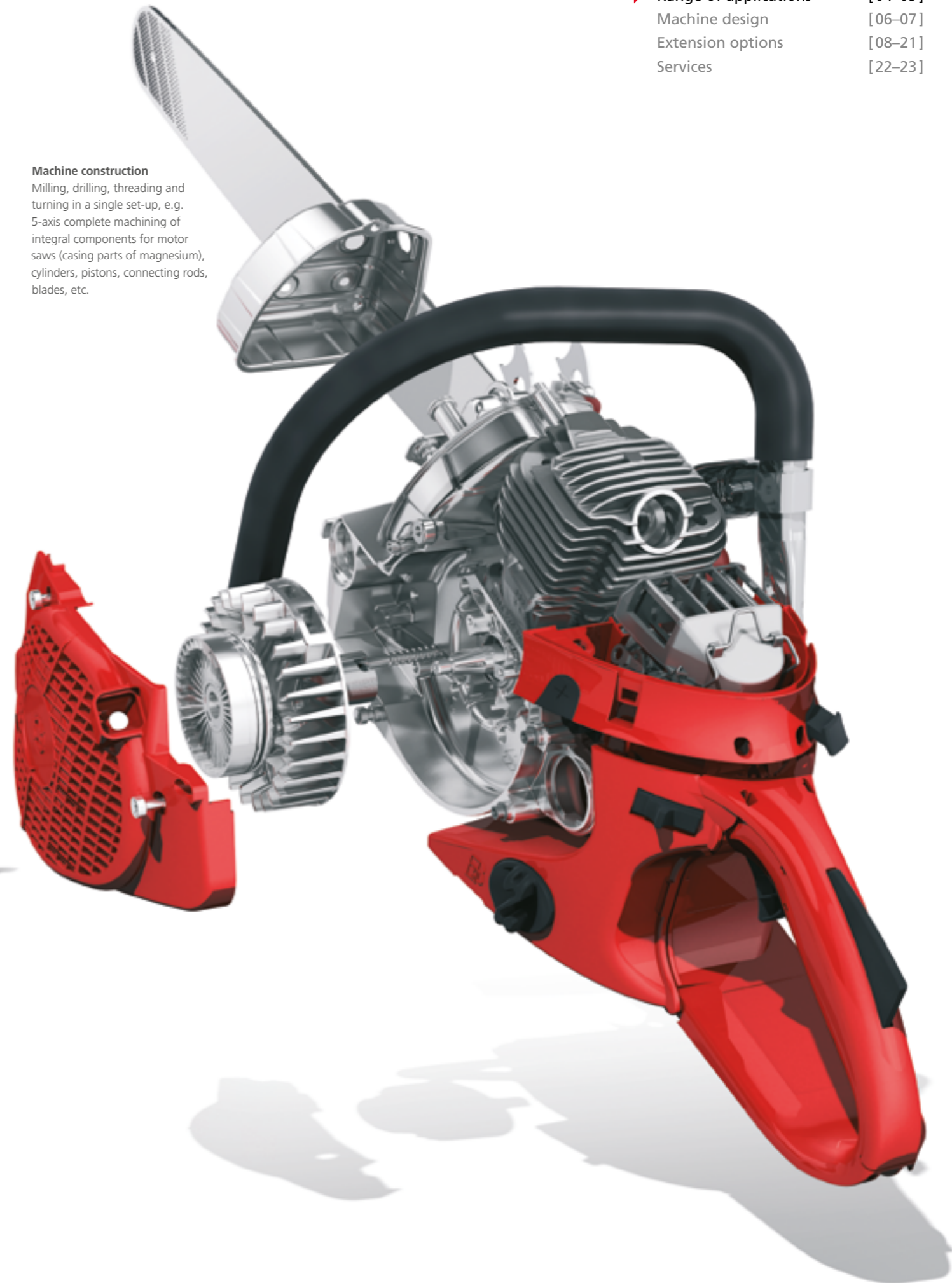

We love perfection ...

That's why we view every detail as an exciting challenge. Whether automotive, aerospace, mechanical engineering, medical or precision engineering – the high-quality machining centers of the CHIRON 15 Series reduce processing times, produce excellent surfaces and compress your manufacturing process into the smallest space possible. The perfect tools to implement your product ideas quickly, with micron-level precision.

Market leaders trust us.

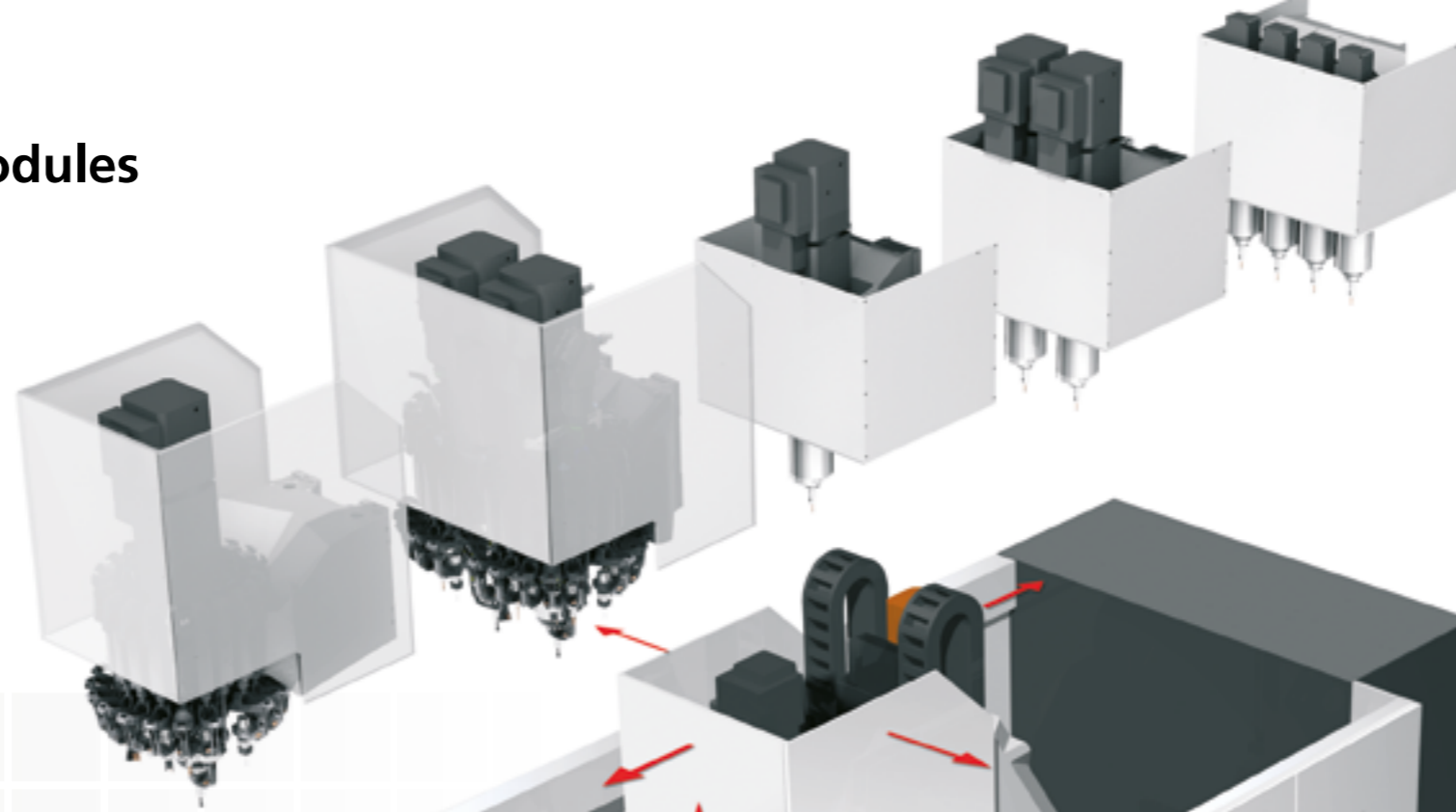

Versatility through high-tech modules

Perfectly suited to any application



Range of applications	[04–05]
▶ Machine design	[06–07]
Extension options	[08–21]
Services	[22–23]

Spindles & spindle systems:

-  FZ: Proven single-spindle machining center in a vertical traveling column design
-  DZ: Highly productive double-spindle machining centers with a spindle clearance of 250, 320 or 400 mm
-  TZ: Highly productive four-spindle machining centers with a spindle clearance of 3 x 200 mm

FZ15 W

Compact, fast single-spindle machining center with integrated basket tool changer and integrated workpiece changing device 0°/180° for easy loading and unloading during machining.

Tool changing systems:







-  CHIRON basket tool changer with 20 (2 x 12 for double-spindle machines) tool places (SK 40 or HSK 63). High productivity due to chip-to-chip times as short as 1.7 s.
-  Automatic tool change using the pick-up method from 0.9 s for 48/64 tool places (DZ 2 x 24/32 / TZ 4 x 14), HSK 63.
-  Background magazine for the provision of up to 158 tools during machining.

Table options:

-  S: Fixed table with plenty of space for various devices or NC rotary table assemblies for multi-sided machining.
-  FX: 2-axis swivel rotary table with one or two face plates (Ø 1 x 280 / 2 x 280 mm) for single- or double-spindle multi-sided machining.
-  W: Workpiece changing device with table loading up to 400 kg per side and large clamping surfaces up to 2 x 940 x 470 mm, borehole pattern, central distribution for power supply lines.



CNC controls of the 15 series: Siemens, Fanuc



Highest precision: Glass scales and digital drive technology allow high acceleration and contour accuracy.

Modular concept:

- Vertical traveling column principle
- Compact installation area from width 1,620 mm x depth 3,620 mm (W)
- Mineral cast machine bed
- High rigidity and thermal stability
- Precision glass scales on all axes
- Dynamic direct drives and precision guides
- High running, positioning and long-term precision
- Robust CHIRON rotary axes
- Fully enclosed work area, stainless steel covers
- Smooth, steep walls for ideal chip flow directly to the chip conveyor
- Ergonomic operating and loading concept
- Service friendly access to all auxiliary units
- High durability, low maintenance



The right machine for each component

Proven modules for customized configurations

Flexible work areas
and maximum paths:
X=730, Y=400, Z=425 mm

Range of applications [04–05]
Machine design [06–07]
► Extension options [08–21]
Services [22–23]

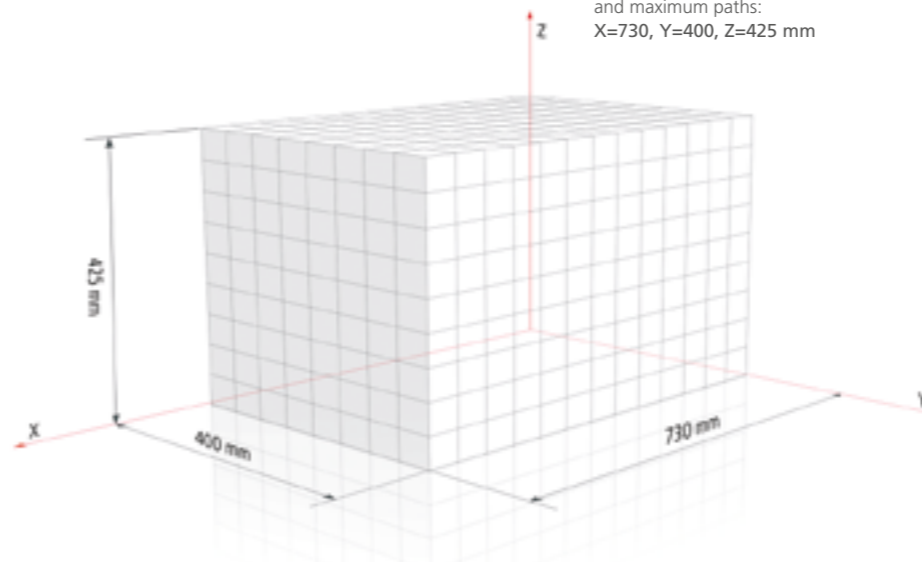

		Spindles & spindle systems			
		Automatic tool changer			
		Table options			
		S	FX	W	MP
FZ	BASKET	FZ15 S	FZ15 FX	FZ15 W	FZ15 MP
FZ	CHAIN	FZ15 S	FZ15 FX	FZ15 W	
DZ	BASKET	DZ15 S	DZ15 FX	DZ15 W	
DZ	CHAIN	DZ15 S	DZ15 FX	DZ15 W	
TZ	CHAIN	TZ15 S		TZ15 W	



Process advantages:

- Maximum path [X–Y–Z] 730–400–425 mm
- Maximum power 58 kW (30% ED)
- Spindles / clearance DZ 2 / 250 or 320 mm
- Spindles / clearance TZ 4 / 200 mm
- Maximum spindle speed 20,000 rpm
- Chip-to-chip time ab 1.7 s
- Axis acceleration X–Y–Z max. 12 m/s²
- Rapid feed as fast as 75 m/min
- Max. number of tools 158
- Tool taper SK 40 / HSK 63
- Maximum tool weight 10 kg
- Maximum tool diameter 175 mm
- Max. tool length 300 mm
- Automatic workpiece change from 1.9 s



FZ15 FX

Fast precision machining center with a basket tool changer and a 2-axis swivel rotary table for 5-axis simultaneous and complete machining. Workpieces can be machined with high surface quality in one set-up.



DZ15 FX

Highly productive double-spindle machining center with a 2-axis swivel rotary table and two face plates. 5-axis simultaneous operations are carried out using high-performance control options.



DZ15 W

Highly productive double-spindle machining center with a fast basket tool changer (2 x 12 tool places) and workpiece changing device for loading and unloading during machining.



FZ15 MP

Multifunctional machining center for the complete machining of workpieces of different lengths from extruded profiles. Whether milling, tapping, counter-sinking, reaming or cutting – everything is possible.

Diversity and flexibility

Reliable technology and high precision as a foundation

FZ15 S

Flexible precision machining center with the fast basket tool changer. The fixed table provides ample space for various devices or NC rotary table assemblies.

FZ15 W

Fast precision machining center with automatic pick-up tool changer and workpiece changing device for loading and unloading during machining.

Range of applications	[04–05]
Machine design	[06–07]
► Extension options	[08–21]
Services	[22–23]

The workpiece changing device is equipped with a central distribution for power supply lines and provides ample space for various devices or NC rotary table assemblies. Downtimes are greatly reduced due to loading and unloading during machining.

The integrated workpiece changing device can be configured as desired by the customer with a swivel plate for individual set-ups. There is also the option of integrating one or two 2-axis swivel rotary tables for 5-axis machining.

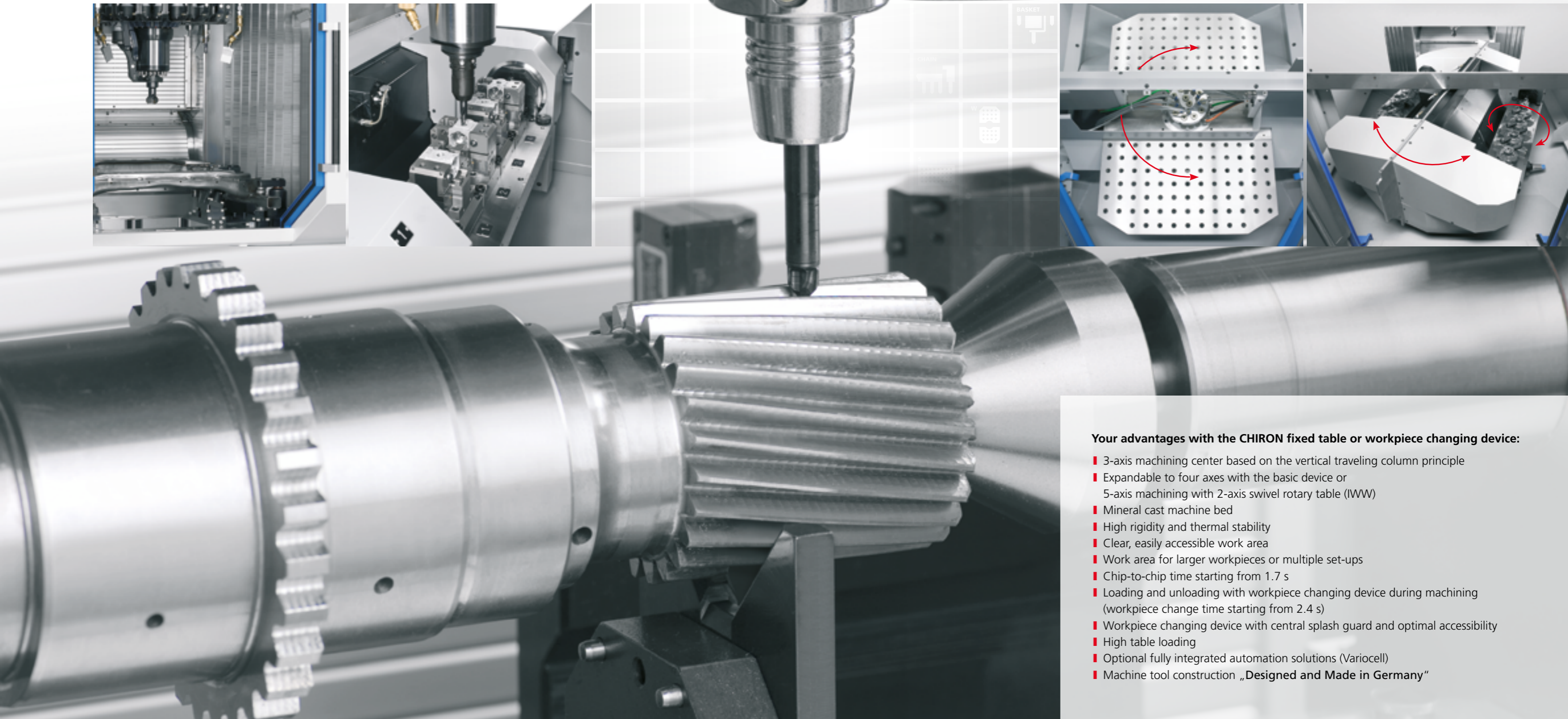
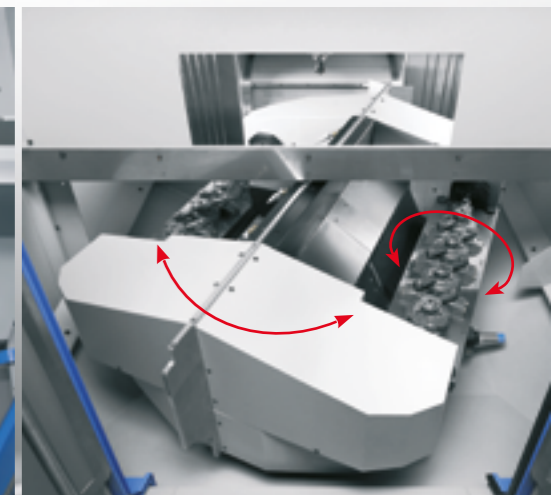
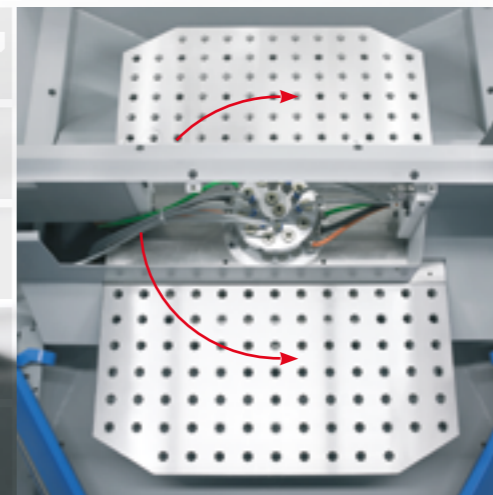

Your advantages with the CHIRON fixed table or workpiece changing device:

- 3-axis machining center based on the vertical traveling column principle
- Expandable to four axes with the basic device or 5-axis machining with 2-axis swivel rotary table (IWW)
- Mineral cast machine bed
- High rigidity and thermal stability
- Clear, easily accessible work area
- Work area for larger workpieces or multiple set-ups
- Chip-to-chip time starting from 1.7 s
- Loading and unloading with workpiece changing device during machining (workpiece change time starting from 2.4 s)
- Workpiece changing device with central splash guard and optimal accessibility
- High table loading
- Optional fully integrated automation solutions (Variocell)
- Machine tool construction „Designed and Made in Germany“

Precision and dynamics at the highest level

Complete machining with CHIRON Five axis

Range of applications	[04–05]
Machine design	[06–07]
► Extension options	[08–21]
Services	[22–23]

FZ15 FX

Fast precision machining center with the fast CHIRON basket tool changer and a 2-axis swivel rotary table. High productivity, with chip-to-chip times as short as 1.7 seconds and tool changing times from 0.9 seconds.

DZ15 FX

Doubled productivity with minimal space requirements: fast double-spindle machining center with a 2-axis swivel rotary table with two face plates for efficient complete machining with five simultaneously controlled axes.



Five-axis machining with the CHIRON rotary table program:

- Solid and reliable technology – developed and manufactured by CHIRON
- Backlash-free preclamped precision gears with high overload capacity and large holding torque
- Rotation option due to high-precision torque drives

The workpiece is positioned exactly in the center of the swivel axes, which minimizes compensating movements of the linear axes. The unique CHIRON basket tool changer allows extremely short cycle times. Combined with fast rapid feeds and the dynamic NC swivel rotary tables, non-productive times are reduced to a minimum.

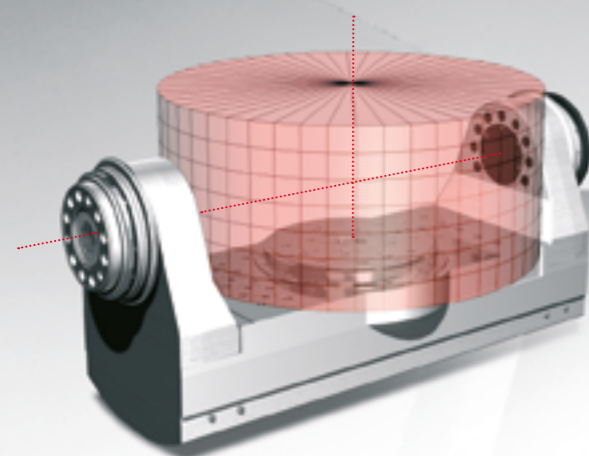

	FZ15 FX	DZ15 FX
■ Maximum workpiece dimensions	Ø 700 x 425 mm	2 x 320 x 425 mm
■ Interference range	Ø 650 mm	Ø 650 mm
■ Spindle clearance (DZ)		250 / 320 / 400 mm
■ 2-axis swivel rotary table CASD	280	280-2
- Swivel range	± 120°	± 120°
- Face plate (n)	Ø 280 mm	2 x Ø 280 mm
- Borehole pattern	M 16 x Ø 15H7x 50 mm	M 16 x Ø 15H7x 50 mm
■ Tool places basket / chain	20 / 48 - 158	2 x 12 / 2 x 24 - 2 x 104
■ Tool change time	0.9 s	0.9 s

Your advantages with CHIRON FX:

- Highest precision in positioning and simultaneous operation
- High rigidity and thermal stability
- Mineral cast machine bed
- Spindle speed up to 20,000 rpm
- Excellent surface quality
- Integrated CHIRON 2-axis swivel rotary table with direct measuring systems
- Integrated 6-way energy supply for clamping device on the face plate
- Zero-point clamping systems can be integrated
- Fourth axis with a pivoting range of up to +/- 120°
- 5th axis with TORQUE drive up to 1,000 rpm for turning work
- Automatic machine compensation due to the 3D touch probe TS27
- Optional fully integrated automation solutions (Variocell)
- Machine tool construction „Designed and Made in Germany“

Manufacture up to 75% faster

Increase profits with 2 or 4 spindles

Range of applications	[04–05]
Machine design	[06–07]
► Extension options	[08–21]
Services	[22–23]

The multiplier effect – more spindles, more cutting, more profit: Doubled productivity on one machine means a reduction in machining time of nearly 50%. There is also the option of multi-sided machining using an NC-controlled rotary axis.

DZ15 FX

Fast, double-spindle machining center with basket tool changer and a 2-axis swivel rotary table with two face plates for economical 5-axis complete machining.

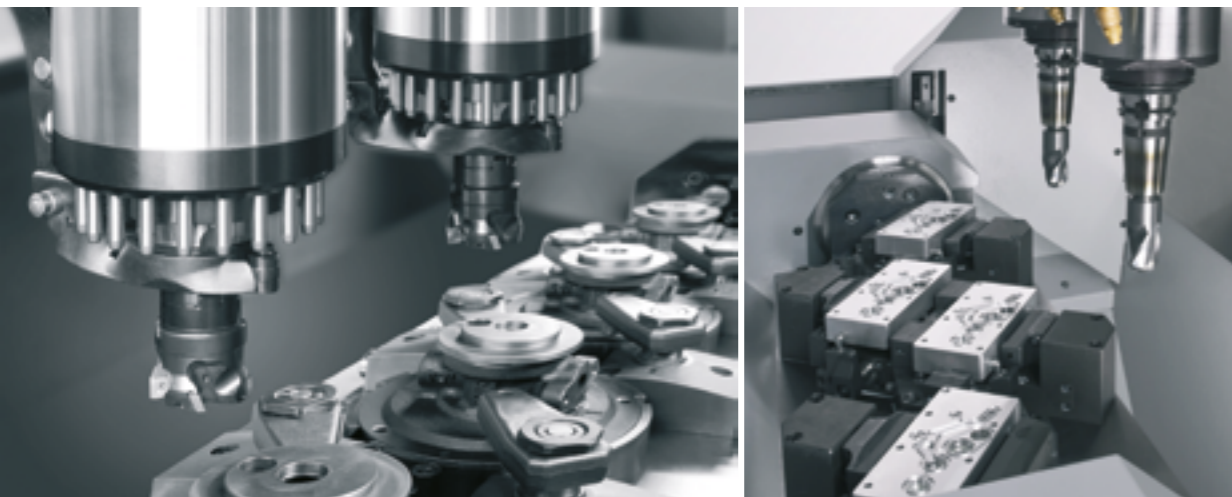

DZ15 W

The combination of two spindles and a fixed table, or workpiece changing device 0°/180°, as well as a quadruple clamping device results in cost savings of up to 50%. (Figure: with the CHIRON basket tool changer)

DZ15 W

A perfect combination of two spindles with a fixed table or workpiece changing device 0°/180°: (Figure: with an NC rotary table and a quadruple clamping device for multi-sided machining)

Your advantages with CHIRON multi-spindle machining:

- Reduction of energy and space requirements
- Reduction of total processing time
- Simplification of material flow
- Reduced investment costs
- Reduced staff resources
- Water-cooled motor spindles up to 20,000 rpm
- Spindles / clearance DZ 2 / 250 or 2 / 320 mm
- Spindles / clearance TZ 4 / 200 mm
- High rapid-feed speeds of up to 75 m/min
- Highest precision in positioning and simultaneous operation
- Precision glass scales on all axes
- CHIRON 2-Achs-Schwenkrundtisch möglich
- Chip-to-chip time starting from 1.7 s
- CHIRON 2-axis swivel rotary table optional
- Optional fully integrated automation solutions (Variocell)
- Machine tool construction „Designed and Made in Germany“

TZ15 W

An economical combination of four high-performance spindles and workpiece changing device. (Figure: with an NC rotary table and a quadruple clamping device for multi-sided machining)

Multifunctional by the meter

Complete machining of extruded profiles with the CHIRON MultiProfile

Range of applications	[04–05]
Machine design	[06–07]
▶ Extension options	[08–21]
Services	[22–23]

FZ15 MP

Multifunctional machining center for the complete machining of workpieces of different lengths from extruded profiles of any type. Milling, drilling, threading, countersinking, reaming or separating – anything is possible, regardless of whether series parts or variants are being machined.



Your advantages with CHIRON MP:

- Automatic production of consecutive workpieces
- Profile sizes up to 150 x 150 mm
- Lower costs per unit due to high productivity of the process
- Spindle speeds up to 20,000 rpm
- High production quality by machining in one set-up
- Cost-effective clamping design
- Minimal set-up effort for different batch sizes and variants
- Quick retooling for manufacturing variants
- Autonomous manufacturing
- Can be easily automated with different loading and unloading systems
- High durability, low maintenance
- Machine tool construction „Designed and Made in Germany“



- Rectangular profiles
- Round profiles
- Flat profiles
- W profiles
- C profiles
- H profiles
- T profiles
- Z profiles
- U profiles
- Customized profiles
- ...

With the machining center FZ15 MP, you can process workpieces of any length directly from the extruded profile – continuously and completely. The profiles are precisely guided between two synchronized NC rotary axes, accurately positioned and firmly clamped. The raw material is automatically advanced by the feed unit. The workpiece is discharged via a practical unloader.

Automatically a step further

Flexible automation solutions for more production time

Variocell UNO

A flexible and cost-effective solution with a compact unit consisting of a machining center, a handling robot and a workpiece storage system for virtually unmanned operation and high process safety.



Machining center and robot cell as one unit – integrated automation in the smallest possible space: transported together, no separate setup, no need for additional alignment of the robot cell or for further protective devices.



Range of applications	[04–05]
Machine design	[06–07]
▶ Extension options	[08–21]
Services	[22–23]

Variocell SYSTEM – Customized automation solutions:

- Machine-integrated spindle grippers
- Portal and articulated-arm solutions
- Load and unload devices
- Pallet changing systems
- Pallet storage for raw and finished parts
- Interlinked systems and much more



Pallet storage for up to 12 raw part pallets (400 x 600 mm) at a distance of 45 mm. For larger workpieces, the number of pallets is reduced. Pallets for raw and finished parts can be exchanged any time during machining.

Customized automation solutions including: Autonomous production due to the use of a pallet changer/storage with loading and unloading portal robot.

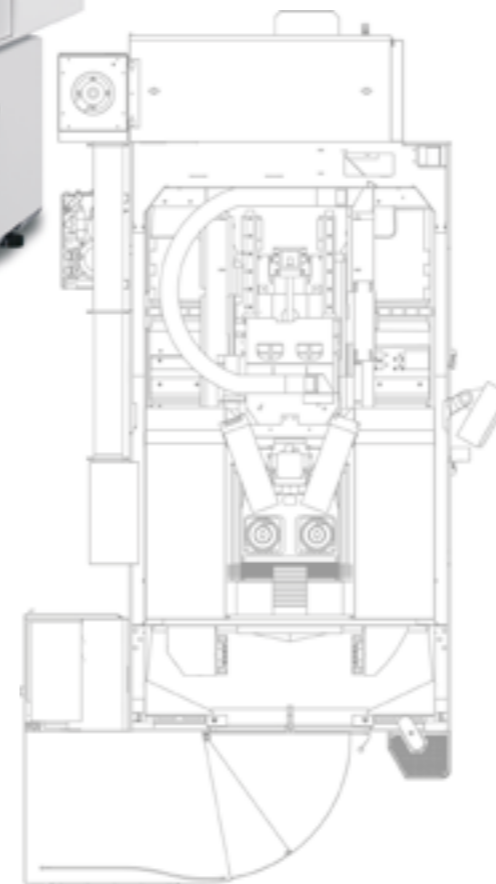

Your advantages with CHIRON Variocell UNO:

- Integrated automation in the smallest possible space (< 1,5 sq. meter)
- Machine and automation as a unit – no safety fence
- Simple installation and set-up as well as in-plant repositioning
- High efficiency for more profit
- High storage capacity
- Simple operation and programming
- Raw and finished part pallets can be replaced during machining
- Double gripper robot for quick workpiece change (option)
- Integrated measuring part discharge (for instance SPC parts)
- Unrestricted access to the work area in the manual mode
- Robot can be used for additional tasks
- Machine tool construction „Designed and Made in Germany“

Options for your production

individualized to meet your specific requirements

Range of applications [04–05]

Machine design [06–07]

► Extension options [08–21]

Services [22–23]

CHIRON laser control for tool breakage checks, for tool measurement and for machine compensation.

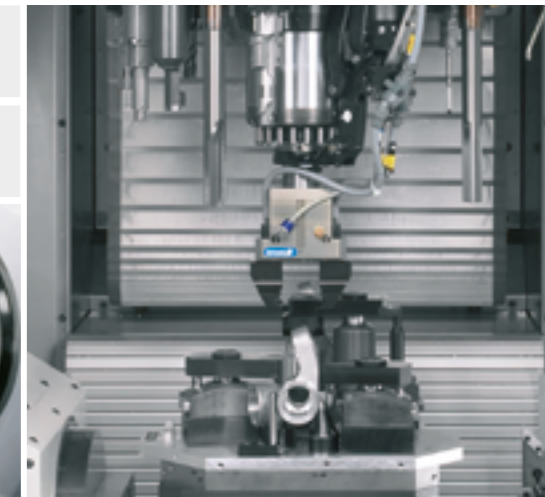
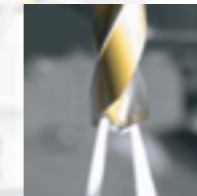
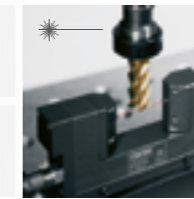

Internal cooling via the spindle up to 70 bar; also available with a frequency-controlled pump.

Stationary 3D probing system TS 27 for tool length measurement, tool breakage checks as well as machine compensation.

Workpiece gripper in the main spindle for machine-integrated workpiece handling.

Series 15 – further options:

- High Speed Plus package
- Reinforced spindle drive
- Work area suctioning unit
- Connection for central suctioning unit
- Energy-efficiency package with an intelligent energy-saving control
- Automatic doors
- Zero point clamping systems
- Oil package with fire-extinguishing system
- Background magazine with a shelf construction
- Robot interface and much more

Background magazine for the provision of up to 187 tools during machining.

From the planning stage to serial production

The whole range of competence from one source – CHIRON TURNKEY

Range of applications	[04–05]
Machine design	[06–07]
Extension options	[08–21]
▶ Services	[22–23]

Analyzing:
Your requirements are our challenges



Conceptual designing:
Innovative technologies efficiently implemented



Specifying:
Perfection – to the finest detail



Implementing:
Precisely the agreed upon performance



Today, just manufacturing excellent machining centers is no longer enough. The user rightly expects a solution, which is as individual as it is intelligent. Starting from one specific machining task, a „Turnkey process“ is to be developed around the workpiece based on quantity structure and constraints. The CHIRON TURNKEY makes it possible to optimally solve complex tasks.

Together with perfectly adapted technology modules, CHIRON engineers create the most economical solution from one source to meet the customer's special needs. This ensures decisive competitive advantages for CHIRON customers. CHIRON not only offers the machining solution itself, but also the support to keep manufacturing running at an optimal level.



CHIRON turnkey solutions

- Comprehensive process design
- Expert engineering
- Experienced project management
- Validation of statistical process capability
- Ensuring targeted productivity
- Production support during the start-up phase
- Training in operation and programming
- CHIRON Service available around the world

CHIRON worldwide

Germany

CHIRON Werke GmbH & Co. KG
Kreuzstraße 75
78532 Tuttlingen, Germany
Tel. +49 7461 940-0
Fax +49 7461 940-53000
info@chiron.de
www.chiron.de

CMS-GmbH

Gewerbepark „take-off“ 125
78579 Neuhausen ob Eck, Germany
Tel. +49 7461 940-3700
Fax +49 7461 940-53701
cms@chiron.de
www.pre-owned-machines.com

France

CHIRON Technologies
de Production SAS
14 Chemin de la Litte
92390 Villeneuve-la-Garenne, France
Tel. +33 1 479 859 50
Fax +33 1 479 854 31
info@chiron-technologies.fr
www.chiron-technologies.fr

Italy

CHIRON Italia S.p.A.
Via Ambrosoli 4/C
20090 Rodano Millepini - MI, Italy
Tel. + 39 02 953 211 02
Fax + 39 02 953 286 20
info@chironitalia.it
www.chironitalia.it

Turkey

CHIRON Istanbul
Makine Ticaret ve Servis Ltd. Şti.
MURAT PAŞA MAHALLESİ ULUYOL
Caddesi No:19 İSTANBUL TOWER
Plaza Kat:13 D:59-60
34040 Bayrampaşa - İSTANBUL, Turkey
Tel. +90 212 612 12 11
Fax +90 212 612 48 28
info@chiron-turkey.com
www.chiron-turkey.com

Poland

CHIRON Polska Sp. z o.o.
ul. Darwina 42
44-177 Paniowki, Poland
Tel. +48 32 790 9850
info@chiron-poland.com
www.chiron-poland.com

USA

CHIRON America INC.
10950 Withers Cove Park Drive
Charlotte, NC 28278, USA
Tel. +01 704 587 95 26
Fax +01 704 587 04 85
info@chironamerica.com
www.chironamerica.com

Detroit Office
44692 Helm Street
Plymouth, MI 48170
Tel +01 734 233 9650
Fax +01 704 587 0485
info@chironamerica.com
www.chironamerica.com

China

CHIRON Machine Tool (Beijing) Ltd. China
Room 1805, NUO Office
A2 Jiangtai Road, Chaoyang District
Beijing 100016, PRC
Tel +86 10 6598 9811
Fax +86 10 6598 9812
info@chiron-china.com
www.chiron-china.com

CHIRON Machine Tools (Taicang) Co., Ltd.

No.1-1, Fada Road
Technological Development Zone,
Taicang 215413, Jiangsu Province
P.R. China
Tel. +86 512 5367 0800
Fax +86 512 5367 0808
info@chiron-china.com
www.chiron-china.com

India

CHIRON India Machine Tools
Private Limited
#33, Naseer Affinity , 1st Floor
Miller Tank Bund Road, Kaveriappa Layout
Vasanth Nagar, Bangalore - 560 052, India
Tel. +91 80 4905 6490
Fax +91 80 4905 6450
info@chiron-india.com
www.chiron-india.com



- Production, Sales & Service
- Sales & Service
- CHIRON Partner

CHIRON Group

chiron

STAMA

SCHERER
FEINBAU

CHIRON Werke GmbH & Co. KG

Kreuzstrasse 75
78532 Tuttlingen, Germany

Phone +49 7461 940-0
Fax +49 7461 940-53000